



Online Home Edition Manual & User Guide



WARNINGS AND NOTICES

NOTICE

- This game is intended to be operated for amusement purposes only. It is not to be operated in violation of any federal, state, or local laws or regulations. As the owner and/or operator of this game you are responsible for its operation in compliance with such laws and regulations. The factory settings for this game may require adjustment in order to comply with the laws and/or regulations in the jurisdiction where the game is located. It is the sole responsibility of the operator to determine what laws and/or regulations are applicable and to make any adjustments to the game before operating it for its intended purpose.
- This manual and the information contained within is subject to change without notice.
- The Showpiece cabinet is intended for use with the Showpiece Integrated Stand (Model 304S) Use of any other integrated or physically attached stand or other hardware is not intended: IT does not approve or inspect any third-party products for use with its Showpiece cabinet. Any damage or injury caused by use of other integrated stand or physically attached hardware is not covered by warranty and IT specifically disclaims any and all liability for such damage or injury.

WARNING

- Use of unauthorized parts or making any unauthorized modifications will void the warranty and may result in the game operating in an unsafe or incorrect manner.
- If the supply cord is damaged, it must be replaced by a special cord or assembly available from the manufacturer or its service agent.
- This cabinet is not suitable for installation in an area where a water jet would be used. The cabinet must not be cleaned by a water jet.

WARRANTY, REPAIR, AND RETURN POLICY

- 90-day warranty on all electronic components. All warranty periods begin on the date of purchase from Incredible Technologies, Inc.
- There is a minimum \$75.00 service charge for all non-warranty repairs or returns.
- For all servicing, return to Incredible Technologies, Inc.
- ANY non-factory repair or attempted repair voids warranty.

RETURN MERCHANDISE AUTHORIZATION

- All returned merchandise must have a Return Merchandise Authorization (RMA) number marked clearly on the outside of the package.
- You must obtain all RMA numbers from Incredible Technologies. Please have the product's Cabinet Identification Device (CID) number available when calling for an RMA number.
- Merchandise returned without an RMA number will not be accepted.
- Warranty may be void if serial number or security labels are tampered with or removed. **Opening the Nighthawk Chassis system will void your warranty.**
- Advance replacement hardware will be shipped to the customer address on file unless specified otherwise.
- Advance replacement hardware will be billed to the customer until Incredible Technologies, Inc. receives the returned merchandise, at which time a credit will be issued.
- All repairs and/or replacements will ship as soon as possible after receipt or request (subject to availability).

PAYMENT FOR AND STORAGE OF REPAIR MATERIALS

- Materials sent to IT for repair must be paid for according to current price schedules and in a reasonable time. Storage fees for repaired equipment will be charged at a rate of \$50.00 (Fifty US Dollars) per calendar month or fraction thereof after 90 (Ninety) days from notice to the customer that the repairs are complete. IT reserves the right to resell repaired equipment to cover accumulated storage charges when the accumulated storage charge reaches 100% (One Hundred Percent) of the repaired items' then-current replacement cost.

- INCREDIBLE TECHNOLOGIES, INC

GT HOME SUBSCRIPTION TERMS AND CONDITIONS

If your GOLDEN TEE HOME subscription was not set up when your unit was purchased, you should either call 847-870-7027 or email goldenteehome@itsgames.com from your registered email address to request account activation. You will receive instructions or a call back to get you set up. The following terms and conditions apply:

- 1) There is a subscription fee for access to the GOLDEN TEE HOME network service. It may be paid either monthly or yearly. The current rate can be found on IT's website <http://home.goldentee.com>, by calling 847-870-7027, or emailing goldenteehome@itsgames.com and inquiring.
- 2) To set up a subscription you must provide a charge card number or other information that can be billed on a recurring basis. Your subscription will remain active until either you or IT elect to cancel it, and will be rebilled each billing period. IT will not send you a reminder or an inquiry before rebilling your card.
- 3) If your billing method fails, IT reserves the right to retry it a number of times or to let your subscription lapse, or both. IT may not contact you before we do either of these things. It is your responsibility to ensure that you have a good payment method on file with IT.
- 4) Subscriptions can only be cancelled by calling 847-870-7027 or emailing goldenteehome@itsgames.com
- 5) There are no refunds for partially billed subscription periods.
- 6) IT is not liable for connectivity problems that may interfere with your ability to connect to the GOLDEN TEE HOME network service. Connectivity problems should be discussed with your Internet Service Provider. IT will not provide technical assistance for network connectivity problems unrelated to the unit itself.
- 7) IT does not provide Internet access as part of the GOLDEN TEE HOME network service. You must have an adequate connection to the Internet for the unit to be able to connect with our network.
- 8) IT will from time to time, either on a scheduled basis or as required, take the GOLDEN TEE HOME network service off line for maintenance. Maintenance outages are considered a reasonable and customary interruption in the provision of the GOLDEN TEE HOME network service. No credits or refunds will be issued for unplayable periods during such maintenance.
- 9) While your subscription is active, IT will use reasonable efforts to provide you with access to the service. However, any refund or credit for downtime or other problems shall be at IT's sole discretion. Your sole remedy for such downtime is to cancel your subscription to the service.

PERPETUAL SOFTWARE LICENSE

Incredible Technologies, Inc. ("IT,") hereby offers you ("Licensee") the right to install and use certain copyrighted computer software produced by IT under the following terms and conditions. This License shall govern the use of the software known as "Golden Tee GOLF Home Edition" ("Update") either as supplied installed on an IT Golden Tee GOLF Home Edition cabinet or when applied as an update to pre-existing Golden Tee GOLF-equipped hardware (either form of cabinet collectively "GT Cabinets") equipped with an earlier version of any other IT software, including but not limited to previous versions of the Golden Tee GOLF Home Edition software ("Prior Version.")

1) Licensing Fee

The Licensing Fee ("LF") shall be as follows:

- US\$0.00 (Zero United States Dollars and zero cents.)

2) Term

The License shall be valid on the first date that both the LF is paid for the Update and it is installed on a GT Cabinet. If the Update has been offered or sold to you under the terms of a Term Software License, the terms of this License shall become applicable if and when the Term Software License terminates in favor of this Perpetual Software License, as set forth in the Term Software License. The term shall be perpetual and throughout the Universe for the Update on the GT Cabinet upon which it is installed at the time the LF is paid. Updates are not transferrable to any other GT Cabinet, for any reason. If a GT Cabinet with an Update is destroyed or otherwise taken out of operation, this License shall terminate.

3) License Rights

Licensee shall have the right to utilize the Update on authorized GT Cabinets in the normal course of business and as controlled by the Rules of ITNet, as set forth in a separate "Operator Agreement" document, the terms and conditions of which, where not conflicting with the terms and conditions herein, are hereby incorporated by reference. Updates may only be operated on GT Cabinets which are installed in commercial locations, as that term is defined by IT, and to which there is general access by all parties with a general right to enter the location where the GT Cabinet is operated.

4) Legal Operation

Updates include various features which may not be lawful to operate in any given jurisdiction. No provision of any feature, or its licensure to Licensee under the terms herein shall be deemed as advice that operation of that feature is lawful or not lawful in any given jurisdiction. Licensee shall make reasonable efforts to disable any user-adjustable feature which they know or should have known as not lawful to operate in the location where a GT Cabinet with an Update is being operated.

5) Termination and Rollback

In the event that this License is terminated for whatever reason, Licensee shall have absolutely no right to operate any GT Cabinet upon which an Update has been installed. IT reserves the absolute right, at its sole discretion, to terminate the operation of any GT Cabinet upon which an unlicensed Update is installed. If Licensee wishes to restore such a GT Cabinet to operating condition without acquiring a new License for the Update, IT will roll-back that GT Cabinet, at no charge to the Licensee, to the Prior Version upon return (at Licensee's expense) of the required hardware to IT's service center.

6) Governing Law and Jurisdiction

The validity and construction of this License and of the rights and obligations set forth herein shall be determined and governed by the laws of the State of Illinois. The parties hereby submit to the Jurisdiction of any state or federal court in Cook County Illinois. Licensees operating outside the borders of the United States of America, regardless of their citizenship or residency, explicitly agree to allow any assets they may have in the USA or any other foreign country to be attached, garnished, forfeited or otherwise reached by any legal act if, after due process of law, they are found to be liable to IT for damages by reason of breach of this License.

7) Warranty

If the Licensee discovers any physical defect in the media (disk, EPROM, flash media, etc.) on which the Update is distributed or in the documentation, which in the opinion of Incredible Technologies, Inc. (IT) prevents the product from being used as reasonably intended, IT will replace the media or documentation at no charge. The purchaser must return the item to be replaced, with proof of purchase, to IT within 90 days after taking delivery of the Update.

8) Disclaimer and Waiver of Remedies

Acceptance of this License and installation of the Update includes disclaimer and waiver of any and all implied, statutory, or common-law warranties, including warranties of merchantability and fitness for a particular purpose, and limits the purchaser's remedy to returning the Update to IT for replacement.

IT makes no warranty or representation, either express or implied, with respect to Updates, their quality, performance, merchantability, or fitness for a particular purpose. Updates are licensed "as is," and the Licensee, by installing the Update, assumes the entire risk as to their quality and performance other than as explicitly set forth herein.

Acceptance of this License and installation of the Update includes disclaimer and waiver of any and all direct, indirect, special, incidental, or consequential damages arising out of the use or inability to use the Update, even if advised of the possibility of such damages. The warranty and remedies set forth above are exclusive and in lieu of all others, oral or written, express or implied. No person, seller, dealer, agent, or employee is authorized to make any modification or addition to this limited warranty.

In jurisdictions which do not allow the exclusion of implied warranties or liability for incidental or consequential damages, acceptance of this License and installation of the Update includes stipulation that the most minimal requirements of the law of those jurisdictions shall govern any additional required additional rights of Licensee.

9) Severability

If any provision of this License shall be held by a court of competent jurisdiction to be illegal, invalid or unenforceable, the parties nevertheless agree that the court should endeavor to give effect to the parties' intentions as reflected in the provision, and the remaining provisions shall remain in full force and effect.



Online Home Edition Manual & User Guide

TABLE OF CONTENTS

| | |
|--|----|
| TABLE OF CONTENTS | 1 |
| SHOWPIECE CABINET | 3 |
| Showpiece Cabinet Contents..... | 3 |
| Leg Leveler Adjustment | 3 |
| Mount Main Screen Display | 3 |
| Install Marquee..... | 3 |
| HDTV DIP SWITCH SETTINGS and NIGHTHAWK SYSTEM BOX..... | 4 |
| Video Connections for 720p/1080p HDTV | 5 |
| INSTALL SECONDARY MONITOR for Showpiece | 6 |
| ABOUT THE SECONDARY MONITOR..... | 6 |
| Final Check..... | 6 |
| Apply Power | 6 |
| General Cabinet Maintenance..... | 7 |
| Care and Cleaning of Rubber Bumper..... | 7 |
| Nighthawk Air Filter | 7 |
| Trackball Maintenance | 7 |
| Care and Cleaning of Cooling Fans and Vents | 7 |
| Showpiece Cabinet Repair Procedures | 8 |
| Nighthawk System Box | 8 |
| I/O Board | 8 |
| Control Panel | 9 |
| Speakers | 10 |
| SYSTEM SETUP MENUS..... | 11 |
| Navigating The Menu System..... | 11 |
| Entering System Setup Mode | 11 |
| Selecting a Menu | 11 |
| Choosing a Menu/Option | 11 |
| Changing a Value..... | 11 |
| Main Menu | 11 |
| General Settings | 12 |
| Operator Adjustables | 12 |
| General Adjustments..... | 12 |
| Upper Monitor Settings | 13 |
| Sound Adjustments | 13 |
| Reset to factory settings | 13 |
| System Tests | 14 |
| Video Tests | 14 |
| Color Test..... | 15 |
| Contrast Test..... | 15 |
| Screen Size Adjustment..... | 16 |
| Sound Tests | 16 |
| Player Control Tests..... | 16 |
| Hardware Tests..... | 17 |

| | |
|--|----|
| Hardware/Software | 17 |
| System Info | 18 |
| USB Info | 18 |
| Version Info | 18 |
| Check Hard Drive | 19 |
| Check Cooling | 19 |
| Check Card Reader | 19 |
| Troubleshooting Shortcuts | 20 |
| Golden Tee Settings & Audits | 20 |
| Golden Tee Settings | 21 |
| Casual Golf Spotlight Player | 22 |
| Spotlight Player Prize Settings | 22 |
| Golden Tee Audits | 23 |
| Reset Leaderboards & Records | 23 |
| ITNet Settings | 24 |
| Communication Settings | 24 |
| Configure Ethernet Settings | 25 |
| Connection Tests | 25 |
| TROUBLESHOOTING & REFERENCE | 26 |
| APPENDIX A Troubleshooting Guide | 26 |
| APPENDIX B – SHOWPIECE Input/Output Connections (I/O Power, Trackball, etc.) | 31 |
| APPENDIX C Replacement Part Numbers | 32 |
| APPENDIX D Nighthawk Component Diagrams | 33 |
| APPENDIX F Menu Navigation Shortcuts | 37 |
| Game Icon Descriptions | 37 |

NOTE

PLEASE RETAIN ORIGINAL SHIPPING BOX FOR SERVICE AND REPAIR.

Do NOT perform any installation or repair when the cabinet is powered on. Make sure the cabinet is unplugged from all power sources before and during installation.

Some game features may not be allowed in certain state or local jurisdictions. Be sure to check your local laws before activating or allowing any features that may be questionable in your area. Adjust game settings from the System Setup Menus. Refer to this manual for details.

Incredible Technologies cabinets are shipped with the USB cables disconnected from the I/O Board and the Cabinet Identification Device (CID). This prevents vibrations during shipment from damaging the contacts on the connectors. These cables must be connected before operating the equipment.

IT recommends disconnecting these USB cables whenever transporting the unit.

SHOWPIECE CABINET

SHOWPIECE CABINET CONTENTS

(1) Golden Tee GOLF Online HE Showpiece Cabinet

Shipped inside a plastic parts bag attached to the front of the cabinet:

- (1) Marquee Header
- (1) Power Cord
- (1) Game Manual
- (1) HDMI Cable

Shipped inside the cardboard sleeve on the top of the control panel:

(2) Marquee Header Brackets

NOT Included with your Showpiece Cabinet

You will need to supply a digital display for the game's main monitor, and an appropriate stand or wall mount. Be sure that the stand or wall mount is UL listed. Incredible Technologies recommends a 42" HDTV that supports 720p or 1080p for the best presentation, game play and earnings potential. A list of Recommended Mounting Solutions can be found under Purchasing Info and Specs at the following address on the IT web site:

<http://amusement.itsgames.com/Amusement/Products/GoldenTee/GTLive2014/specs.jsp>



LEG LEVELER ADJUSTMENT

Once your game is in position at the location, it is necessary to adjust the leg levelers. The leg levelers will help stabilize the game on an uneven floor, and help it from moving or shifting during game play. The game is shipped with the two front and two rear leg levelers installed. Adjust the levelers as necessary to level and stabilize the game.

MOUNT MAIN SCREEN DISPLAY

Position the Showpiece cabinet in front of an HDTV. Incredible Technologies recommends either a 720p or 1080p flat panel HDTV from 32" or larger.

The HDTV can be mounted to a wall or to an appropriate display stand. There are many different types of wall mounts and floor stands available through retail, wholesale and Internet outlets. Be sure that the wall mount or stand you select must be UL listed. Be sure that the top of the Showpiece cabinet has at least 24" clearance in all directions. Insufficient clearance may result in damage to your display or player injury.

Recommended height for your display may vary depending on your location and player base. As a general rule, the minimum height of the bottom of the display viewing area should be 42" from the floor.

INSTALL MARQUEE

Your Showpiece cabinet comes with a framed marquee header that can be easily attached to the top of your monitor. The brackets for the header are shipped inside a separate cardboard insert labeled *Parts – Do Not Discard* within the cabinet packaging. The insert is located on the top of the control panel.

First, attach the two brackets to the back of the universal mounting plate you are using for your HD display. The brackets share the same screws used to affix the display to the mounting plate, and are sandwiched between the plate and the back of the monitor. Once the brackets are in place, slide the marquee frame onto the clips on the two newly mounted brackets. Be sure the tab on the clips rest inside the channel on the marquee frame.

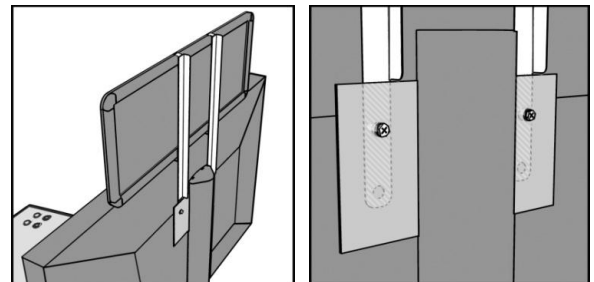

HDTV DIP SWITCH SETTINGS AND NIGHTHAWK SYSTEM BOX

Before making any Nighthawk connections, make sure the USB cables are connected for the I/O Board and CID. See Complete System Box Connections for details.

Nighthawk System Box

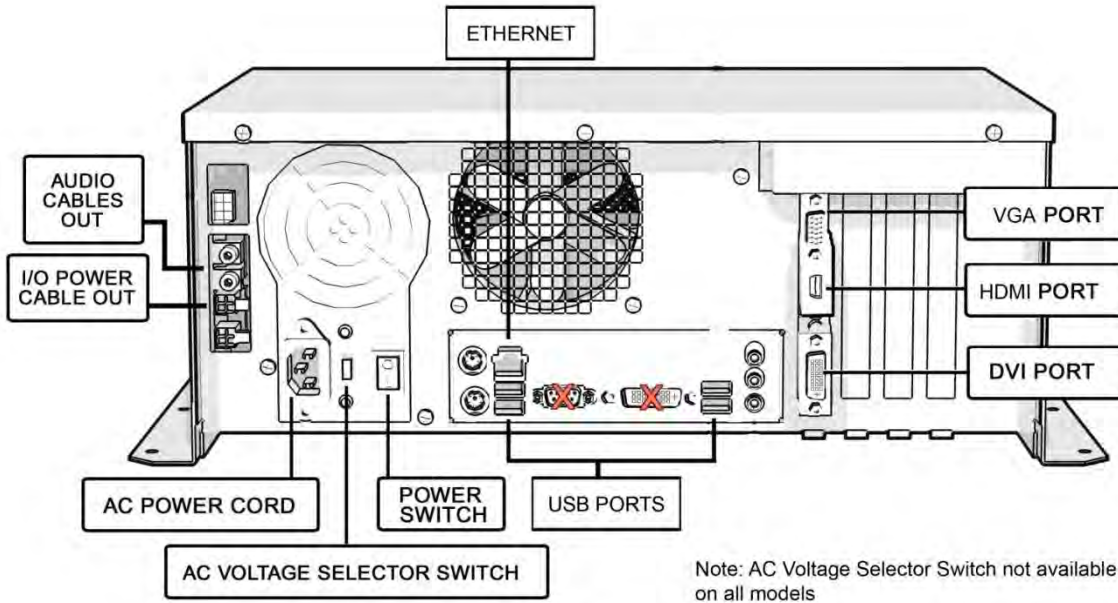

DIP Switch Settings for HDTVs

The DIP switch settings in your Showpiece cabinet have been factory set to accommodate a 1080p HDTV connected through HDMI cables. DIP switch bank Sw201 on the I/O Board controls the video resolution for the main monitor. If using a DVI-D or VGA connection, or for different resolutions such as 720p, use this chart:

HDTV MONITOR APPLICATION

IMPORTANT NOTE

I/O CARD DIAGRAM FOR ORIENTATION

RESOLUTION SETTINGS

| | |
|--|---|
| <p>1 2 3 4 OFF ON</p> <p>1280 x 720 (HDMI) 720p</p> | <p>1 2 3 4 OFF ON</p> <p>1280 x 720 (SVGA) 720p</p> |
| <p>1 2 3 4 OFF ON</p> <p>1280 x 720 (DVI-D) 720p</p> | <p>1 2 3 4 OFF ON</p> <p>1920 x 1080 (HDMI) 1080p DEFAULT</p> |

Sw201 Sw200 Sw202

ADDITIONAL SETTINGS

| | |
|---|---|
| <p>Primary Monitor</p> <p>1 2 3 4 OFF ON</p> <p>Primary Monitor has 16 x 9 Aspect Ratio DEFAULT</p> | <p>Secondary Monitor</p> <p>1 2 3 4 OFF ON</p> <p>Optional 2nd Monitor has 16 x 9 aspect ratio DEFAULT</p> |
| <p>System Setup</p> <p>1 2 3 4 OFF ON</p> <p>Enter System Setup Menus</p> <p>1 2 3 4 OFF ON</p> <p>Exit System Setup Menus DEFAULT</p> | <p>1 2 3 4 OFF ON</p> <p>Do Not Flip Optional 2nd Monitor DEFAULT</p> <p>1 2 3 4 OFF ON</p> <p>Vertical Flip Optional 2nd Monitor</p> |

Sw200 ALWAYS ON
Do Not Change
Settings shown for Showpiece

Note: In the Additional Settings above, ONLY the ON switch matters for correct setup and operation.

Notes:

A reboot is required when changing resolutions
 Video and audio connections to HDTVs vary, and may require additional cables not included with the Showpiece cabinet. Also, some displays may not support the resolution needed for your game. Check your display's manual for additional information.

VIDEO CONNECTIONS FOR 720P/1080P HDTV

Golden Tee Golf Showpiece 2014 supports 1920x1080 (1080p) and 720p (1280x720) resolutions. Be sure your HDTV is compatible.

For any questions related to Showpiece cabinet connections, see the Showpiece Connections Guide at <http://amusement.itsgames.com/Amusement/Support/Manuals/>

If you plan to use a **Single HDTV** as your only video output, follow the instructions below.

Connect to HDMI

Connect the HDMI cable (supplied) to the HDMI output on the Nighthawk system. Route the cable through the clip under the lock on the back wall, and down through the access panel on the back of the cabinet. Connect the other end of the HDMI cable to the proper HDMI input on your television.

Set Up Your HDTV

Refer to the HDTV manual to adjust the video signal to match the correct input for your game. Selecting the correct input is commonly found from a system menu accessed from the remote, or an Input Select button on the HDTV.

Audio Connections for HDMI

The HDMI cable will also supply audio to the speakers on your HDTV. See Audio/Video Connections Table below for details on other connection types.

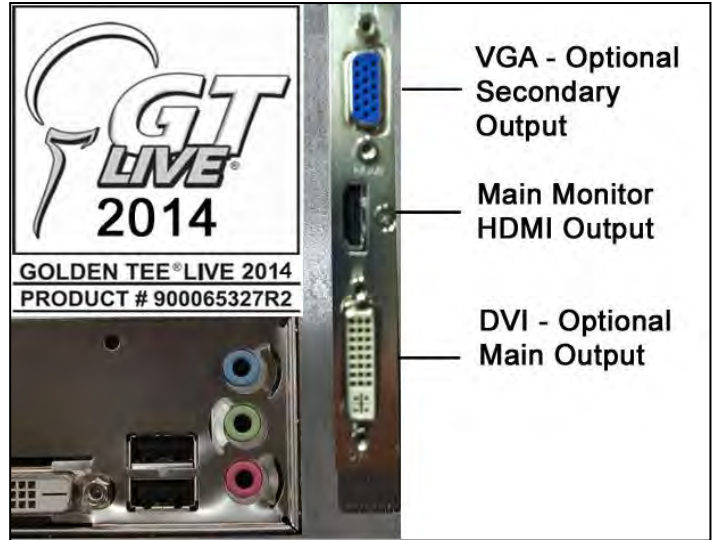

Audio/Video Connections Table

| Video Mode | Primary Video Connector | Audio | Secondary Video Connector |
|------------------------|--------------------------------|---|-------------------------------------|
| 1920x1080 (HDMI) 1080p | HDMI with HDMI Cable | Digital - Via HDMI cable | VGA (top port see image above) |
| 1280x720 (HDMI) 720p | HDMI with HDMI Cable | Analog - Via I/O Board or HDTV analog input | VGA (top port see image above) |
| 1280x720 (DVI-D) 720p | DVI-D to HDMI | Analog - Via I/O Board or HDTV analog input | VGA (top port see image above) |
| 1280x720 (SVGA) 720p | VGA (top port see image above) | Analog - Via I/O Board or HDTV analog input | Not Available – Single monitor only |

INSTALL SECONDARY MONITOR FOR SHOWPIECE

If you plan to use Two TVs for your video outputs, follow the instructions below.

ABOUT THE SECONDARY MONITOR

Most Incredible Technologies games, including Golden Tee GOLF, support a secondary monitor. The second monitor in Golden Tee displays unique information, including game replays and advertising screens. Most other games from IT support a second monitor to display the main game screen, so more of your players can see the action. Golden Tee GOLF can also show the main display on the second monitor. See the System Setup Menus section of the Golden Tee 2014 manual.

Incredible Technologies recommends using a 16:9 computer monitor. In all cases, the second monitor requires a VGA connection from the Nighthawk system box to the digital display of your choice. See the Sw202 DIP switch settings on the HDTV Monitor Application chart.

FINAL CHECK

APPLY POWER

Connect the power cable to the socket on the back of the cabinet. Then plug the cable into a 3-pronged, grounded wall socket. Locate the power switch on the back of the cabinet and turn it ON.

Note: If the supply cord is damaged, it must be replaced by a special cord or assembly available from the manufacturer or its service agent.

Watch the game carefully when you first turn it on. Look and smell for smoke. Turn it OFF immediately if there is smoke. Make sure the fan inside the system box is running and the LEDs on the I/O Board are flashing. If not, something is wrong, turn off the game.

Check the Cabinet ID Device (CID) Number

Watch the screen during boot-up and wait for the Golden Tee boot verification screen to appear. Note the Cabinet ID Number (CID) that appears on this screen, and verify that it matches the CID number printed on the back of the cabinet. The screen will automatically time out and boot-up will continue.

Cabinet Temperature

The state of the art Nighthawk hardware is extremely powerful, and therefore generates a substantial amount of heat. Measures have been taken to keep the various components cool during normal use. If overheating occurs, game play and hardware longevity may be affected. Use the Check Cooling menu in the System Setup menus to monitor the temperature within your cabinet. Reach under the front right side of the cabinet and press the Test button to access the game's System Setup software menu system. Once at the main System Setup menu, use the trackball and Start button to select *Troubleshooting Shortcuts*, then *Check Cooling*.



GENERAL CABINET MAINTENANCE

Games that are in good working condition, with clear monitors, clean control panels and working trackballs are easier to play and more fun than those in poor condition. It is definitely worth your time and attention to protect your investment with a little common care. Each week, clean the display and wipe down the control panel to bring back that new game look. Test the trackball and buttons regularly to make sure they are playing properly.

CARE AND CLEANING OF RUBBER BUMPER

The rubber bumper on the front of the cabinet's control panel is made from durable nitrile rubber. Clean it using a mild soap and water solution or blue window cleaner.

NIGHTHAWK AIR FILTER

The Nighthawk System Box comes equipped with an external electrostatic air filter. This filter is held in place by a metal bracket, attached to the system box. The filter prevents debris from entering the system box and damaging the electronic components. A clogged filter will impede airflow, thus building up unwanted heat which can cause damage to your hardware. Be sure to check this filter at least once a month. Remove the filter by sliding it out of its housing. Shake off excess dirt and if necessary clean it with soap and water. Be sure the filter is completely dry before reinstalling the filter.

TRACKBALL MAINTENANCE

The trackball will require periodic maintenance to assure optimum performance. In most cases the inside of the trackball simply needs to be cleaned of any accumulated dust and debris.

To access the inside of the trackball, remove the 6 Phillips head screws that hold the trackball together and remove the top cover. Clean out any dust and debris inside the trackball. Polish the rollers and remove any foreign material that may be on the rollers. Do not lubricate the bearings, as this will only attract more dust. If the bearings do not spin freely it is best to replace the bearing assembly. Inspect the rollers for any nicks that may cause poor performance and replace if needed. Inspect the ball for any nicks and replace if needed. Parts can be obtained from Happ Controls and is an economical option rather than replacing the entire trackball assembly.

It is critical that the green field ground wire be properly connected to field ground. This prevents the trackball from building a static charge that can cause the game to lock up or reset. A static discharge can also damage the trackball's electronic components, as well as the main system.

CARE AND CLEANING OF COOLING FANS AND VENTS

The hardware that runs Golden Tee GOLF Online HE is quite sophisticated, and many of the chips and processors will get hot very quickly. Like your desktop PC, the Golden Tee GOLF Online HE hardware needs adequate ventilation to work properly. Dust and dirt can be a major cause to overheating and will lead to costly repairs. At least once a month, check to make sure the cabinet and system box fans are working and free of dust and debris. Use a vacuum to clear all the ventilation holes on the cabinet at this time as well.

CAUTION:

Incredible Technologies cabinets are shipped with the USB cables disconnected from the I/O Board and the Cabinet Identification Device (CID). This prevents vibrations during shipment from damaging the contacts on the connectors. These cables must be connected before operating the equipment.

IT recommends disconnecting these USB cables whenever transporting the unit.

SHOWPIECE CABINET REPAIR PROCEDURES

NIGHTHAWK SYSTEM BOX

The Nighthawk System Box houses most of the game electronics and hardware in one box that can be easily installed. As with all electronic equipment, the system box should be handled with extreme care. Shock, severe temperature, or sudden impacts can damage the internal components that require costly repair.

Note: Turn off power to the cabinet and remove the power cord from the back of the cabinet when performing any of the following.

System Box Removal

1. Unlock the control panel and open to expose the Nighthawk system box.
2. Disconnect all connections to the system box. Be sure all wires and connectors are clear and out of the way. Label the connectors for easy reconnection.
3. Loosen the 6 ¼" hex-head screws that secure the system box.
4. Carefully lift the system box off the screws and up out of the cabinet.

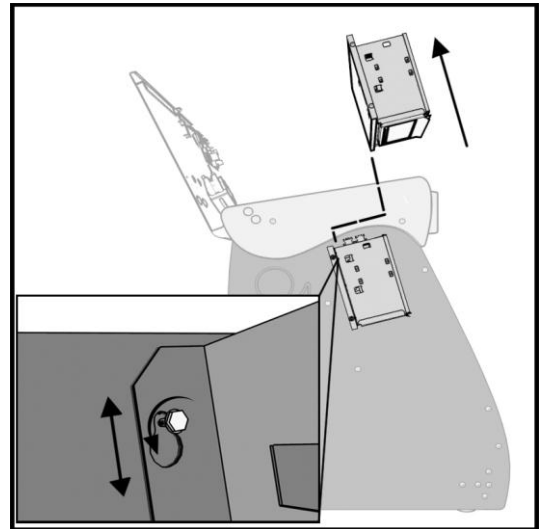

System Box Installation

1. Unlock the control panel and open to expose the inside of the cabinet.
2. Align the system box onto the 6 mounting screws of the internal slanted panel. The connection ports face up. Once the system box is in place, tighten the 6 ¼" hex-head screws to secure the box to the panel.
3. Connect the required connections. See the Connections Diagram for more details.

I/O BOARD

Note: The I/O Board is game title specific and is not interchangeable with other game titles produced by Incredible Technologies on this system. Dedicated and Retrofit Kit I/O Boards are different and are not interchangeable.

I/O Board Removal

First, unlock the control panel and open to expose the interior of the Showpiece cabinet. Disconnect all connections from the I/O Board. Label the connectors for easy reconnection and move them safely out of the way. Next, remove the six ¼" wood screws that secure the board to the interior left side of the cabinet (as you face the game). Carefully remove the I/O Board from the cabinet.

I/O Board Installation

Place the I/O Board in the proper location on the interior left side of the cabinet (as you face the control panel of the game). Be sure it is oriented properly so the cables reach the board (the USB port on the I/O Board facing the top of the cabinet). Secure the I/O Board to the side of the cabinet with the six ¼" wood screws. Use the factory mounting holes if at all possible. Be sure the board does not "bow" or is not stressed in any way. Once mounted, connect the appropriate connections.

Cabinet Identification Device (CID)

This device contains a specific ID number that identifies your cabinet. The CID is a permanent number and must be connected to the main system box via the USB cable and working properly in order for the game to operate.

CID Removal and Replacement

If for some reason you must replace the CID, disconnect the USB cable from the CID. This is the only connection to the CID. Next, remove the four ¼" wood screws that secure the CID to the interior left side of the cabinet (as you face the game). The CID is located above the I/O Board. To install a CID, mount the CID in the proper location using four ¼" wood screws. The CID should be mounted so the USB port is facing the top of the cabinet and the electronics are facing the wall.

Note: The Cabinet Identification Device should **NEVER** be removed from the cabinet, even when replacing any of the other components. The CID is the cabinet's PERMANENT Identifier, regardless of any other components.

Lock

The lock on the rear of the Showpiece cabinet allows access to the Nighthawk system box under the control panel.

Service Button

Mounted under the outer edge of the Showpiece cabinet are controls for System Setup. Reach under the rounded ledge on the front right side of the cabinet and press the red button to access the game's System Setup software menu system. The System Setup menus cover a variety of important areas including collections, tests, game adjustments, and optional settings.

CONTROL PANEL

Opening the control panel provides access to all game controls and hardware components. To open the control panel, simply use the supplied key in the lock on the back of the cabinet and lift from the back. The control panel is hinged in front and will stay open when fully extended.

Soft Power Switch

A "soft power" switch has been added to the underside of the control panel, to assist in the update process. This switch will turn off power to the cabinet so you don't have to reach around to the main power switch located on the back of the cabinet.

Note: If you turn power off using the Soft Power Switch, you **must** use this same switch when turning power back on.

Trackball Replacement

To replace a trackball, open the control panel and remove the 4 long screws holding the trackball in place. Be careful not to lose any of the screws, washers and lock washers. Disconnect the wire harness and ground wire and remove the old trackball. Position the new trackball in the proper orientation over the existing standoffs. Make sure that the arrow on the trackball that points to the monitor is pointing up. Replace the 4 long screws and washers. Do not over tighten! Screw in until the lock washer is fully compressed. Reconnect the wiring connector and ground wire.

Note: The field ground wire is critical to avoid electrical problems and assure optimal performance.

Button Replacement

All of the buttons on the control panel require a 1 1/8th inch hole, and are pre-drilled on the dedicated control panel. To remove a button, disconnect the wires from the button assembly by sliding the wires off of the micro switch posts. Next carefully twist the micro-switch assembly off of the button posts. Finally, unscrew the nut to remove the button from the control panel.

Place the new button assembly into the hole and position the smaller side of the micro-switch housing to face the rubber bumper, angled towards the middle. Tighten the supplied nut using a pushbutton wrench. Do not over tighten. Install the micro-switch by snapping it onto the pushbutton assembly by hand. Position the assembly so the micro switch posts face the rubber bumper, angling towards the middle. Reconnect the wires by sliding the wire assembly onto the contact posts of the appropriate micro switch. See the wiring diagrams in the back of this manual.

L.E.D. Lighted Buttons

The Help and Options buttons on Golden Tee GOLF Online HE are Light Emitting Diode buttons. The housing for the L.E.D. snaps into the back of the button assembly. The L.E.D. must be installed properly for the light to function properly. The Anode/positive side of the L.E.D. is connected to the +5 volts, and the Cathode/negative side of the L.E.D. is connected to the appropriate signal wire. The L.E.D. slides into the housing and the housing is marked Positive and Negative. See the lamps connector J202 in the cabinet wiring diagram in Appendix D.

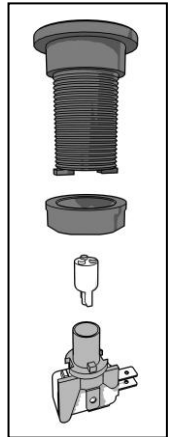

Control Panel Removal

To remove the control panel from its hinge, Disconnect the trackball cable, field-ground wire, and the control panel interconnect connector to the I/O Board. Remove the screw that attaches the safety cable to the control panel. Remove the four 1/4" screws holding the panel to the hinge.

Control Panel Graphics Removal

The control panel artwork has been screened onto a solid sheet of polycarbonate, which is resistant to scratches and burns. Unfortunately long exposure to excessive situations may damage the surface over time. To remove and replace this piece, the pushbutton and trackball assemblies must first be removed. Separate the polycarbonate piece from the wood portion of the panel by starting at one corner and slowly peeling the two apart. The overlay has adhesive on the entire surface and will take some force to separate the pieces due to the adhesive. Once removed, the graphic overlay will not be able to be used again.

Control Panel Graphics Installation

To install a new polycarbonate graphics overlay, make sure the wood control panel surface is clean, smooth, and free from glue, dirt and debris. Remove the paper protecting the adhesive from the new artwork/cover panel. Carefully place it on the wood panel, aligning it properly. Press and smooth firmly to assure that it is secure. Replace the buttons and trackball in the correct orientation.

SPEAKERS

The speakers are mounted in the bottom front of the cabinet, just below the card reader. Sounds and speech are important aspects to the play experience and should be adjusted and maintained for optimal results. Make sure your speakers are in good working condition, are wired correctly, and are grounded properly to avoid buzz or hiss.

Speaker Access

In order to reach the speakers, unlock and raise the hinged control panel. The speakers are located on the front underside of the cabinet. Remove the 4 nuts with an 11/32" nut driver to remove the speakers from their mounting.

Note: Both speakers must be identically wired to work properly. For optimal sounds, both speakers must be in phase with one another. Be sure the positive wire is connected to the positive terminal of each speaker and the negative speaker wire is connected to the negative terminal of each speaker.

SYSTEM SETUP MENUS

NAVIGATING THE MENU SYSTEM

The System Setup menus cover a variety of important areas including tests, game adjustments, and optional settings. You should familiarize yourself with these menus because they are important for changing your game cabinet settings.

ENTERING SYSTEM SETUP MODE

There are two ways to enter System Setup. Reach under the front right side of the cabinet and press the red button to access the game's System Setup software menu system. Or, from the I/O Board, move the DIP switch SW202 position 4 to the ON position. This switch needs to be moved back to OFF to exit the System Setup menus. Refer to the diagram in Appendix D for all DIP switch settings.

SELECTING A MENU

A menu option can be selected at any time by rolling the trackball up or down or by pressing the Left or Right buttons.

CHOOSING A MENU/OPTION

A menu option can be chosen at any time by pressing the Start button.

CHANGING A VALUE

A value can be changed at any time by rolling the trackball left or right.

MAIN MENU

The Main Menu displays five main areas that make up System Setup mode. Please familiarize yourself with these areas, as they will help you maximize your earnings potential.

Collections & Earnings (Not Available)

Not available on Golden Tee GOLF Online HE.

General Settings – See Page 12

This area allows you to change adjustments, perform system tests, and reset your game back to factory settings.

Troubleshooting Shortcuts – See Page 21

This section presents a variety of tests and menus that will help you troubleshoot any problems you may be having with your game. The available sections are also accessible through the other main sections.

Golden Tee Settings & Audits – See Page 21

This area allows you to adjust settings specific to Golden Tee GOLF Online HE including the game adjustments, game audits and leaderboards.

ITNet Settings See Page 24

This section details various ITNet settings, such as game registration and connection settings with ITNet.

Exit

This will exit the System Setup menus and take you back into the game's attract mode.



GENERAL SETTINGS

The General Settings menu has various adjustable settings relating to the cabinet, and is divided into two sections.

Operator Adjustables

This area allows you to adjust options like volume, attract mode sounds, coin message and game mode.

System Tests

This area allows you to perform diagnostics including video adjustments, input tests, and sound tests.

Back

This will take you back to the **Main Menu**.

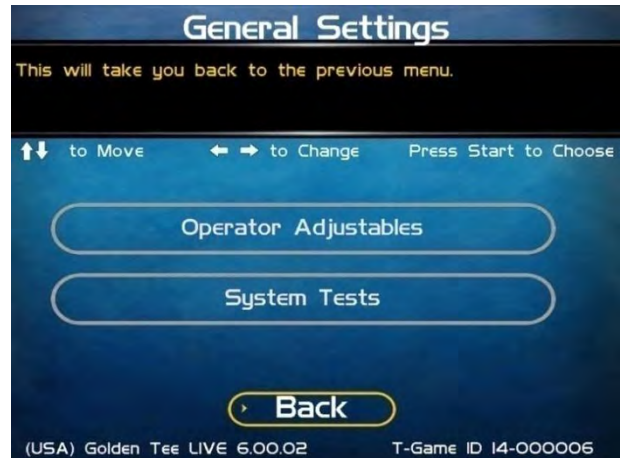

OPERATOR ADJUSTABLES

Operator Adjustables lets you change the game mode and show all advertisements, change sound settings and reset to factory defaults.

General Adjustments

This allows you to adjust options like game mode and advertisements.

Money Slot Adjustments (Not Available)

Not available on Golden Tee GOLF Online HE.

Sound Adjustments

Allows you to adjust the various sound settings including attract mode sounds, game volume, and stereo setup.

Collection Settings (Not Available)

Not available on Golden Tee GOLF Online HE.

Reset to Factory Settings

This option allows you to reset all the settings to factory defaults.

Back

This will take you back to the **General Settings** menu.

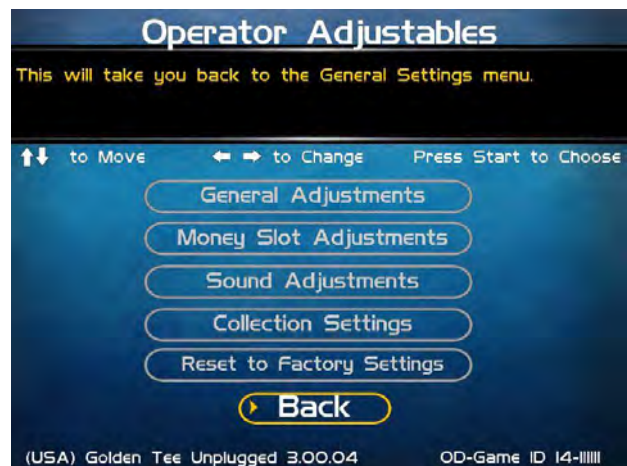

GENERAL ADJUSTMENTS

Allows you to adjust game mode and advertisements settings.



UPPER MONITOR SETTINGS

Allows you to check and adjust the upper monitor connection and output.



SOUND ADJUSTMENTS

In Game Volume

This option lets you adjust the In Game volume from OFF to 100%. **The default is set to 30%.**

Attract Volume

This option lets you adjust the Attract Mode Volume from OFF to 100%. **The default is set to 30%.**

Attract Mode Sounds

This adjusts how often sounds are played in the attract mode: Never, Rarely, Sometimes, Often, and Always. **The default is set to On - Sometimes.**

Stereo/Mono

This option is where you select stereo or mono setup. **The default is set to Stereo.**

Reset Values

This resets all values to their default value located on this page.

Back

This will take you back to the **Operator Adjustables** menu.



RESET TO FACTORY SETTINGS

This resets ALL settings to their default values. A verification screen will display to make sure you agree to the change.

Please Note:

This process may take several minutes to complete.

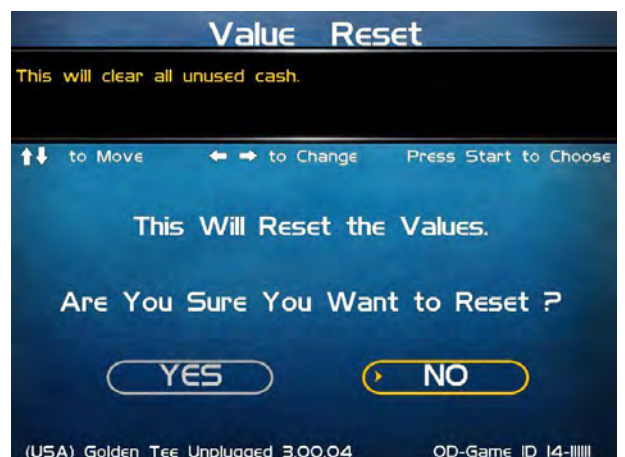

SYSTEM TESTS

This area allows you to perform diagnostics including video adjustments, input tests, and sound tests.

Video Tests

This area has tests that will help you to adjust your game's color, contrast, and screen size.

Sound Tests

This area has tests that will help you adjust your game's audio setup by playing a stored sound, a streaming sound, and testing the speaker(s).

Player Control Tests

This option allows you to test all inputs including trackball, buttons, and money slots.

Mechanical Meter (Not Available)

Not available on Golden Tee GOLF Online HE.

Hardware Tests

This area includes a series of diagnostic screens and tests to help you make sure your game is functioning correctly.

Back

This will take you back to the **General Settings** menu.

VIDEO TESTS

The Video Tests section has a variety of tests that will help you adjust your monitor.

Color Test

This area will take you to a series of tests to adjust your monitor's RGB settings to have each color display properly.

Contrast Test

This area will take you to a series of tests to adjust your monitor's brightness/contrast so the game displays properly.

Screen Size Adjustments

Use this screen to align your monitor so that all the circles appear as circles and the boundary line appears on the edge of each side of the screen.

Back

This will take you back to the **System Tests** menu.



COLOR TEST

Color Grid Adjustment

Adjust your monitor to have each colored box display properly.

Red Screen

Adjust your monitor to have red display properly.

Green Screen

Adjust your monitor to have green display properly.

Blue Screen

Adjust your monitor to have blue display properly.

Back

This will take you back to the **Video Tests** menu.

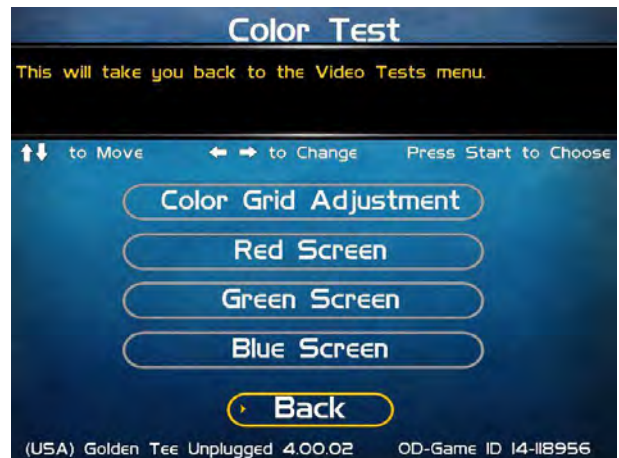

CONTRAST TEST

White Screen

Adjust your monitor to have white display properly.

50% White Screen

Adjust your monitor to have 50% white display properly.

25% White Screen

Adjust your monitor to have 25% white display properly.

Black Screen

Adjust your monitor to have black display properly.

Contrast Screen

This option is a test you can use to adjust your monitor's contrast and brightness settings to have the boxes displayed properly.

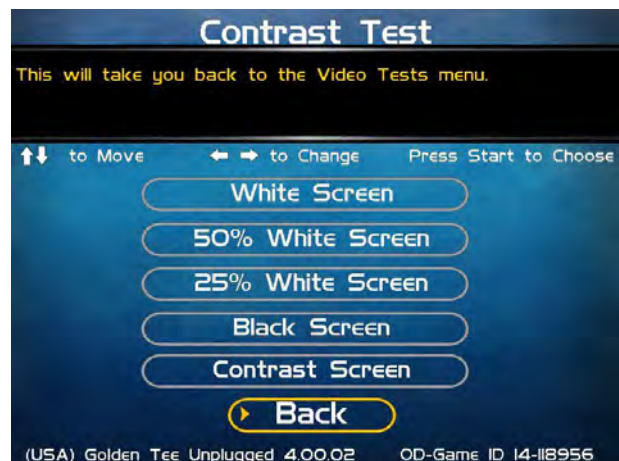

Note: *May not work on older or often used monitors.* If you have a monitor that's old or has been used often you may not be able to adjust the contrast and/or brightness levels accordingly. In this case adjust the monitor for best performance while getting close to the recommended settings.

Contrast Screen

This option is a test you can use to adjust your monitor's contrast and brightness settings to have the boxes displayed properly.

Back

This will take you back to the **Video Tests** menu.

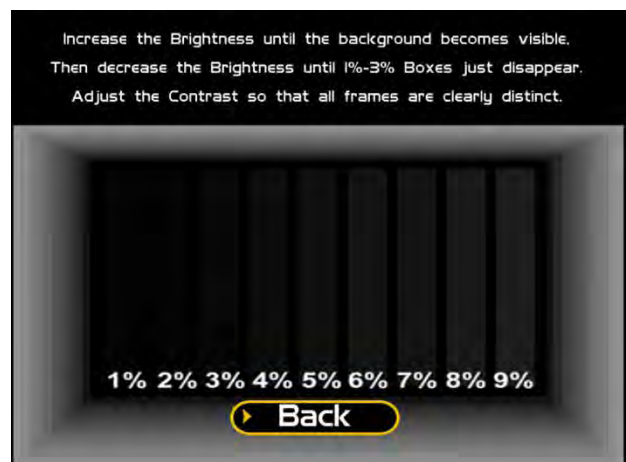

SCREEN SIZE ADJUSTMENT

Use this screen to adjust the size and aspect ratio of your picture. Press the Start button to exit.

If you are using an HDTV display, you may need to adjust this screen to see the complete image. Use the trackball to highlight BIGGER or SMALLER and press the Start button to adjust the screen image. Press DONE to exit.

Note: Adjusting the screen size will prompt a reboot upon exit of this menu.

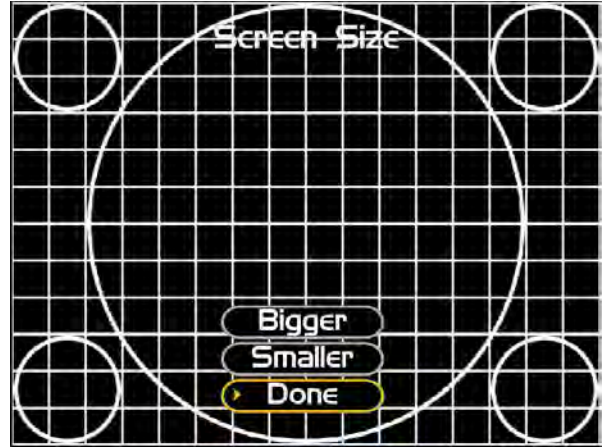

SOUND TESTS

Stored Sound

This will play a stored sound so you can make sure your audio setup is functioning properly.

Streaming Sound

This will play a streaming sound so you can make sure your audio setup is functioning properly.

Speaker Test

This test will say MONO if you have your game set to Mono or LEFT and RIGHT if you have it set to stereo so you can make sure your audio setup is functioning properly.

Back

This will take you back to the **System Tests** menu.



PLAYER CONTROL TESTS

Some of the features on this screen, such as Coin 1 and Coin 2 are not available in the Golden Tee GOLF Online HE.

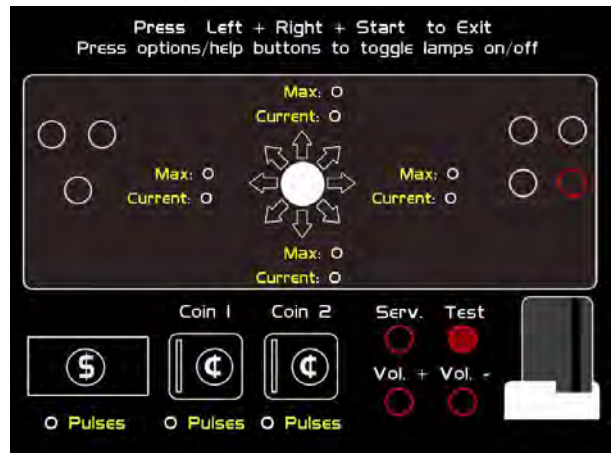

HARDWARE TESTS

This area includes a series of diagnostic screens and tests to help you make sure your game is functioning correctly.

Hardware/Software

This area has options to view your system, USB and version info.

Check Hard Drive

This test checks the integrity of your hard drive's data.

Note: This test can take several minutes.

Check Cooling

This test helps you make sure your game is functioning at the proper temperature and all fans are working.

Check Card Reader

This tests the functionality of the card reader and displays some details about the card tested.

Back

This will take you back to the **System Tests** menu.



HARDWARE/SOFTWARE

System Info

This is a list of your game's current basic system info.

USB Info

This is a list of your game's current USB devices.

Version Info

This is a list of your game's software version information.

Back

This will take you back to the **Hardware Tests** menu.



SYSTEM INFO

This is a list of your game's current basic system information, including Hard Drive, CPU and Video Card.

Back

The Back button takes you back to the **Hardware/Software** menu.



USB INFO

This is a list of your game's current USB devices.

Back

The Back button takes you back to the **Hardware/Software** menu.



VERSION INFO

This is a list of your machine's software versioning.

Back

The Back button takes you back to the **Hardware/Software** menu.



CHECK HARD DRIVE

Check File Data

This test checks the integrity of your hard drive's data. Select **Begin Test** to initiate the process.

Note: This test can take up to 3 hours to complete.

If this test succeeds you will see the message: **Status: Hard Drive Functioning Properly.** If this test fails, you will see the message: **Hard Drive Error (#)**

Select **Back** to skip the test and return to the **Check Hard Drive** menu.

Check File System

This test REBOOTS YOUR GAME and performs a low level systems check of the integrity of your hard drive.

Note: This can take several minutes.

Back

This will take you back to the **Hardware Tests** menu.

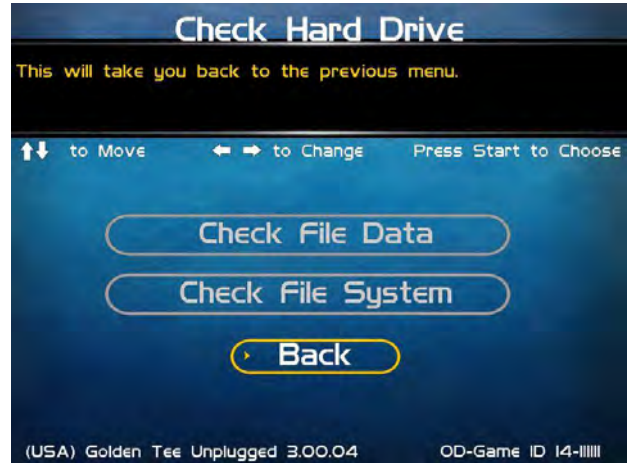

CHECK COOLING

This checks that your game is functioning at the proper temperature and all fans are working. The current status is color-coded for easy viewing. If the results are displayed in green, your cabinet is at normal settings.

Back

The Back button takes you back to the **Hardware Tests** menu.

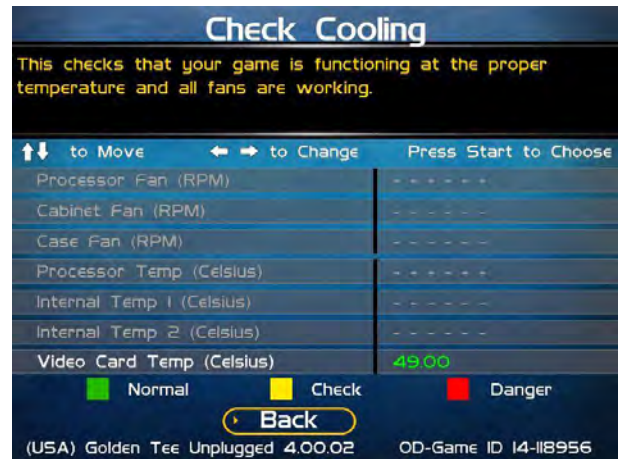

CHECK CARD READER

This test will check to see if your card reader can read and recognize properly encoded IT and credit cards.

From this screen, insert a card into the card reader. If the card can be read, a message will appear on the screen.

Back

The Back button takes you back to the **Hardware Tests** menu.

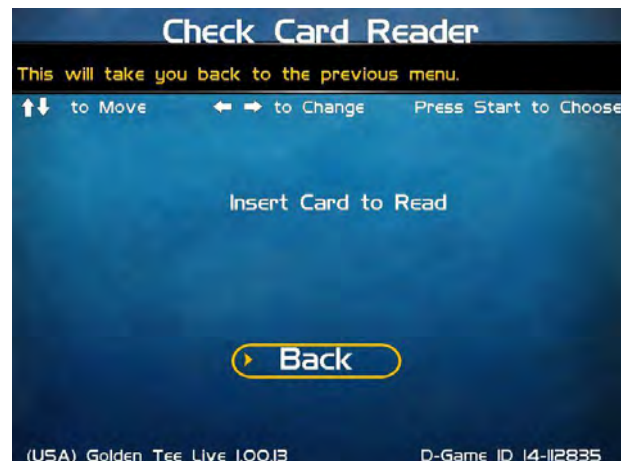

TROUBLESHOOTING SHORTCUTS

This section gathers many of the commonly used tests and menus into one convenient area. Check here first when troubleshooting problems or questions about the integrity of your machine.

The tests that are available in this section are:

Check Card Reader
Check Cooling
Check Hard Drive
Screen Size Adjustments
Communications Settings
Player Control Tests
System Tests

Descriptions of each of these tests and sections can be found elsewhere in this manual.

Back

This will take you back to the **Main Menu**.



GOLDEN TEE SETTINGS & AUDITS

Golden Tee Settings

This allows you to make custom adjustments to certain features, such as the delay of game timer.

Golden Tee Audits

Allows you to view your game play and reset audits.

Player Cost Schedule

Not available on Golden Tee GOLF Online HE.

Reset Leaderboards & Records

Allows you to clear any or all local Leaderboards and high score screens.

Note: This process may take several minutes to complete.

Back

This will take you back to the **Main Menu**.



GOLDEN TEE SETTINGS

Note: Some of these settings can be turned “On” but if listed below as “Not Available” they will NOT Work.

LIVE Prizes (Not Available)

Not available on Golden Tee GOLF Online HE.

Delay of Game Timeout

Adjust the timer that senses activity between shots.

Closest To The Pin LIVE (Not Available)

Not available on Golden Tee GOLF Online HE.

Operator CTP

Activate the ability for the game to enter Closest to the Pin (CTP) mode. This version of CTP does not display any sponsored or branded game elements.

Activate Sponsored CTP (Not Available)

Not available on Golden Tee GOLF Online HE.

Hole-N-Win (Not Available)

Not available on Golden Tee GOLF Online HE.

More

Selecting More brings you to a second page of Golden Tee settings.

Locked Conditions

Activates the ability for the game to allow for special contests where course conditions are the same for each player.

Free Holes in Attract Mode (Not Available)

Not available on Golden Tee GOLF Online HE.

Casual/Skins Difficulty

You can set the difficulty of the courses for casual/skins games but will not impact glory or stats play. Difficulty settings can be adjusted from 1 (easiest) to 5 (hardest). The default setting is 2.

Pre-game Casual Clothing

This setting allows a random selection of 30 clothing items available as a quick selection on all Casual game formats (Casual/Skins). There are 10 random item types of shirts, pants and hats.

Mulligans

Mulligans allow casual game players to retake a bad shot during their game. To disable this feature select OFF.

Allow Casual Straight Shots

This allows casual players the option to choose whether to play with only straight shots or to allow curved shots as in standard settings mode. To disable this feature select NO.

Spotlight Player Settings

These settings allow you to offer prizes for in-home contests based on Golden Tee casual golf game play.

Reset Values

This will reset all Golden Tee Settings to their factory defaults.

Back

This will take you back to the **Golden Tee Settings & Audits page**.



CASUAL GOLF SPOTLIGHT PLAYER

This allows operators to set the prize for a weekly drawing based on all players who achieved a score of PAR +17 or better.

Prize Settings

This opens This Week's Prize Settings to set the prize available for the winner of the drawing.

Clear Last Winner

This removes the last winner from the results.

Reset Values

This will reset all Casual Weekly Drawing settings



SPOTLIGHT PLAYER PRIZE SETTINGS

Edit Prize Text

Enter the text that best explains the prize offered. For example, "Free dinner any week night to this week's winner!"

Remove Prize

Select this option if you do not wish to run a prize drawing.



GOLDEN TEE AUDITS

This section displays various counts and totals for a number of game options. The following values are based on the last reset, the date of which is shown at the top of the screen.

Total Number of 18 hole games
Total Number of 9 hole games
18 hole unregistered contest games
9 hole unregistered contest games
Number of 18 hole stats play
Number of 9 hole stats play
Number of casual 1 hole purchase
Number of skins play purchases

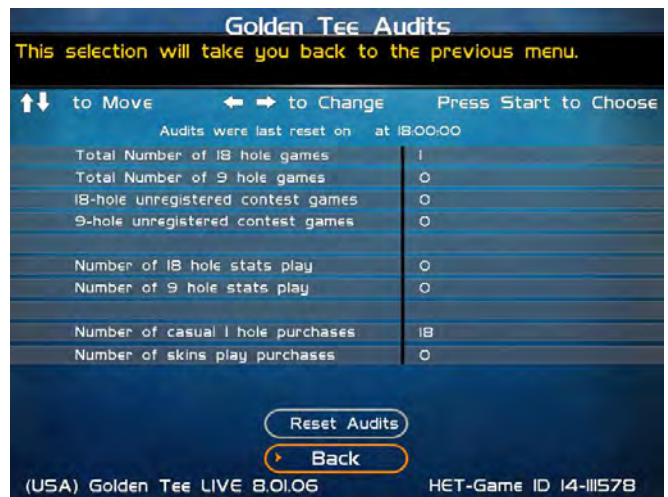

Reset Audits

This will reset all audits to zero, and update the date of the last audit reset.

Back

This takes you back to the previous screen.

RESET LEADERBOARDS & RECORDS

Use this menu to reset various machine-specific Leaderboards.

Reset Leaderboards

This leaderboard is displayed after every hole during a casual game. Use this setting to clear the current play data. This option resets all Local Leaderboards.

Reset Course Records

Course records, such as best score on each course, are displayed on various screens during a game and in the attract mode, and replayed in the game's attract mode. Use this setting to clear all course records and game highlights.

Reset All

Use this setting to clear all Leaderboards, local records and game highlights. This process could take up to a minute to run so please be patient.



ITNET SETTINGS

This section details various ITNet settings, such as game registration and connection settings with ITNet.

Change Location (Not Available)

Not available on Golden Tee GOLF Online HE.

Location Information

This describes the cabinet location.

Communication Settings

This section lets you select and adjust various communication options. It is important for testing the Ethernet signal on your Golden Tee GOLF Online HE cabinet.

Connection Tests

This section tests your communication connections for integrity and reliability.

Re-Activate Modem (Not Available)

Not available on Golden Tee GOLF Online HE.

Back

Select this to return to the **Main Menu**.

COMMUNICATION SETTINGS

This screen shows the type of communication device that is currently in use, and its status and signal strength.

Configure Ethernet Settings

In some cases it may be necessary to reconfigure your Ethernet settings. See following page.

Back

Select this to return to the **ITNet Settings** menu.

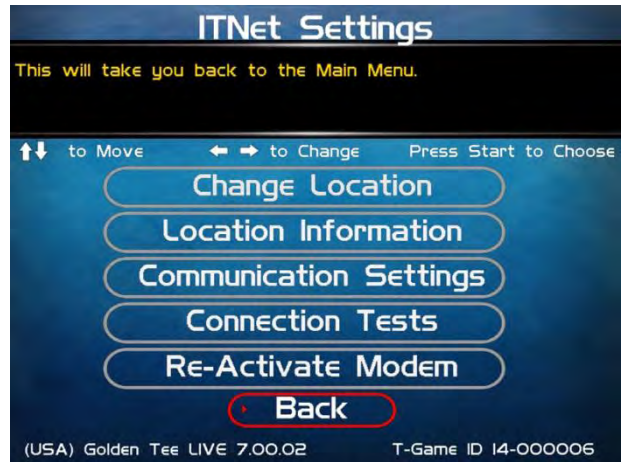

CONFIGURE ETHERNET SETTINGS

Depending on your system setup, you may need to manually set specific settings for Ethernet to work. Use this menu to enter these settings.

Enable DHCP

Set this to Yes if your service provider or your router hardware has DHCP enabled. DHCP automatically sets the IP, Gateway and Net Mask.

If you edit the IP below to anything other than 0.0.0.0, it automatically changes Enable DHCP to No.

If No DHCP, Static IP

Set this to the IP that your service provider issued, or an IP from your router's subnet that is not already being used.

If the IP is set to 0.0.0.0, it automatically changes Enable DHCP to Yes.

Gateway

Set this to the Gateway that your service provider issued, or the IP address of your router. Example: 192.168.1.1

Net Mask

Set this to the Net Mask that your service provider issued, or if you are using a router it is typically 255.255.255.0. Example: 255.255.255.0

Test Ethernet

Selecting this will initiate a network connection using your entered network settings for DHCP or Static IP, Gateway and Net Mask. If the connection succeeds, a latency time check is also performed. Results are displayed at the end of the tests. It is a good idea to perform this test anytime you make changes to any of these settings to make sure everything works.

Back

Select this to return to the **Communication Settings** menu.

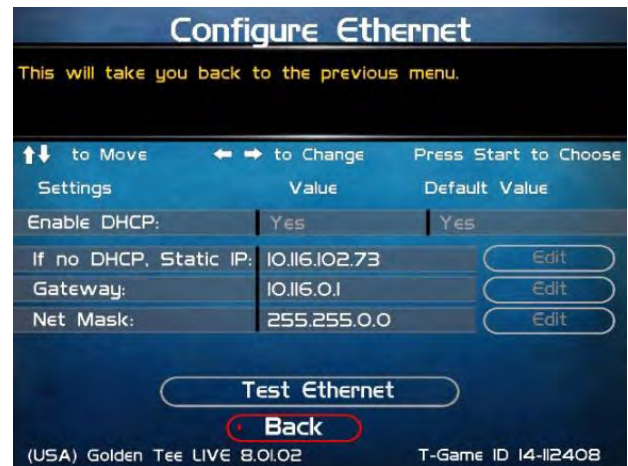

CONNECTION TESTS

Use this section to test the connection to ITNet.

Check Latency Time

This test will measure the time it takes for your game to communicate with ITNet. If successful, the delay time in seconds will be displayed.

Force Call to ITNet

This test will initiate a connection with the ITNet system and give a result status.

Back

Select this to return to the **ITNet Settings** menu.

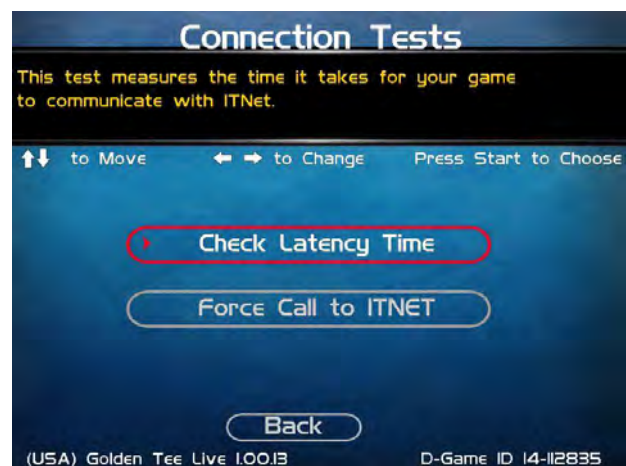

TROUBLESHOOTING & REFERENCE

APPENDIX A TROUBLESHOOTING GUIDE

| Video Problems | | |
|--|--|--|
| Symptom | Probable Cause | Solution |
| No picture on the Monitor | I/O Board DIP Switch settings are wrong. | Adjust DIP Switch settings to match the resolution of the monitor you are using. Refer to I/O DIP Switch Settings in Appendix D. |
| | Incorrect video connection configuration. | Be sure the video connections are correct according to the type of monitor you are using. Refer to the diagrams in Appendix D. |
| | Monitor does not have a proper A.C. voltage input. | Verify A.C. power to the Nighthawk System box. Verify monitor is working on a known good system. |
| | Monitor is defective. | Repair or replace. |
| | Nighthawk System box is defective | Go to Nighthawk System box troubleshooting section. |
| No picture but game sounds are heard | Incorrect video connection configuration. | Verify video is connected to the system correctly. Refer to the diagrams in Appendix D. |
| | Since you hear game sounds the system is working. | Review no picture troubleshooting section above. |
| Scrambled Picture | I/O Board DIP Switch settings are set wrong. | Adjust DIP Switch settings to match the resolution of the monitor you are using. Refer to DIP Switch Settings in Appendix D. |
| | Incorrect video connection configuration. | Be sure the video connections are correct according to the type of monitor you are using. Refer to the diagrams in Appendix D. |
| Entire picture is not seen on the screen or it does not fill the entire screen | Misadjusted monitor. | Adjust the monitor width and height. Use video screen adjustment in system tests. Refer to the monitor manual. |
| Missing or washed out colors | Bad Video connections | Verify continuity from the monitor to the video out on the I/O Board. Red, Green, Blue video signal. <i>Mid. and Low resolution monitors only.</i> |
| | Contrast and brightness on the monitor needs to be adjusted. | Refer to the monitor manual to make adjustments. |
| | Defective Monitor. | Verify by connecting a known good monitor to the system. |

| Sound Problems | | |
|----------------------------------|--|--|
| Symptom | Probable Cause | Solution |
| No audio | Audio Cable between the I/O Board and the Nighthawk system box are not connected. | Verify audio cables are connected. Refer to Appendix D. |
| | Speakers are not connected properly. | Verify continuity from the I/O Board speaker output pins to the speakers. Refer to Appendix D. |
| | Volume is set to the lowest level. | Adjust the volume to an audible level. |
| | Attract mode sounds may be set to all off. You will have sounds when playing the game. | Choose one of the 5 Attract Mode sound options in Sound Adjustments. |
| | Defective I/O Board. | Verify on a known working system. Replace if necessary. |
| | Defective Nighthawk system box. | Be certain all other possibilities are explored before replacing the Nighthawk system box. |
| | DIP switch settings are incorrect for your application | Refer to Monitor Applications at the back of this manual for proper setup. |
| Distorted or scratchy game audio | Bad speaker. | Replace blown speaker. |
| | Loose speaker or grill cover is causing vibration. | Verify all components are installed properly and securely. |
| | Loose/defective audio cables from the Nighthawk system box to the I/O Board. | Check the audio cable connections. Replace cable. |
| | Defective I/O Board. | Verify on a known working system. Replace if necessary. |
| | Defective Nighthawk system box. | Be certain all other possibilities are explored before replacing the Nighthawk system box. |

| Nighthawk System Box Problems | | |
|--|---|---|
| Symptom | Probable Cause | Solution |
| No video and no green lights on the I/O Board. Fans are not heard on the Nighthawk System Box. | No AC power to the Nighthawk System Box. | Verify A.C. voltage is connected to the Nighthawk System Box. |
| | Power switch on the Nighthawk System Box is off. | Flip the Nighthawk System Box power switch to on. |
| | Main cabinet power switch is off. | Be certain the main cabinet switch is set to on. |
| | Soft Power Shutdown | Press the Soft Power button with the power turned on. Or, short the top 2 pins of the 6-pin connector on the system box. See Appendix D. |
| | Defective Nighthawk System Box. | Be certain all other possibilities are explored before replacing the Nighthawk System Box. |
| No video and no green lights on the I/O Board. Fans are heard on the Nighthawk System Box. | DC power cord not connected from Nighthawk System Box to I/O Board. | Connect the DC power cord from the Nighthawk System Box to the I/O Board. |
| | Defective I/O Board. | Try it on a known good system. Verify by disconnecting all cables from the I/O Board except the DC power and USB cable to the Nighthawk System Box. No green lights, replace the I/O Board. |

| Control Problems | | |
|---|---|---|
| Symptom | Probable Cause | Solution |
| Button does not work. | Switches Common post is not connected to digital ground. | Verify continuity to digital/power supply ground. |
| | Signal wire is not connected to the Normally Open post of the switch. | Verify continuity from the I/O Board to the Normally Open post of the switch. |
| | Switch is defective. | Replace defective switch. |
| Button always indicates closed in the player control test. Pressing it will show it is not depressed. | Signal wire is connected to the Normally Closed post of the switch. | Connect signal wire to the Normally Open post of the switch. |
| Button always indicates closed in player control test even with the switch disconnected entirely. | Defective I/O Board. | Test on a known good system. Replace if necessary. |
| Trackball is not functioning in any direction. | Trackball is not connected to the I/O Board properly. | Verify the trackball is connected to J208 labeled trackball on the I/O Board. |
| | Defective trackball Interconnect cable. | Verify continuity on the trackball Interconnect cable. |
| | Trackball is defective. | Replace trackball. |
| | I/O Board is defective | Replace I/O Board. Try it on a known good system. |
| Trackball does not work in a certain direction. | Trackball cable is defective. | Verify continuity on the trackball cable. Repair or replace if needed. |
| | Trackball is defective. | Repair or replace the trackball. Try it on a known working system. |
| | I/O Board is defective. | Repair or replace the I/O Board. Try it on a known working system. |
| Trackball works intermittently. | Inside of the trackball is dirty. | Clean the inside of the trackball. |
| | Rollers are worn. | Replace the rollers and bearings. |
| | Trackball is over-tightened. | Do not over-tighten the trackball. Tighten just enough to flatten the lock washers. |

| HDTV Video Problems | | |
|-------------------------------------|---|--|
| Symptom | Probable Cause | Solution |
| There is no picture during boot up. | Incorrect video cable configuration. | Be sure you are using the proper cable connections. Refer to the HDTV connections configurations. |
| | Connected to the wrong output on the system box | Refer to the HDTV connections configurations. |
| | Connected to the wrong input on the HDTV | HDTVs usually have more than 1 input for a certain input type. Examples are Component 1 & 2; HDMI 1 & 2. |
| | Incorrect input selected on the HDTV | Be sure the correct input is selected from the HDTV input menu. Example: If using HDMI 1 that input must be selected from the HDTV video input menu. |
| | DIP switch setting SW 201 on the I/O Board set incorrectly. | Sw201 on the I/O Board must be configured to match the method of video you are using. |

| Symptom | Probable Cause | Solution |
|---|--|---|
| No picture after boot up | Normal black screen is displayed for a period of time just before 3D graphics are displayed. | This is normal operation. Be sure to wait at least two minutes after LOADING GAME is displayed to see if video appears. |
| | Your VGA cable is connected to the second monitor output. | Connect the VGA connector to the main output port. |
| | Incompatible video mode | Many monitors will not accept SVGA 720p or 800 x 600. 640 x 480 usually works. A commercial grade HDTV will usually work. |
| Distorted or fuzzy picture | Improper cable connection | Be sure the video cables are securely connected at the computer video card and at the HDTV. This is especially critical if using a component video cable. |
| Picture is too big for the screen or does not fill the entire screen. | Incorrect DIP switch configuration. | Be sure Sw201 is configured to match the desired video. |
| | Increase or decrease screen size in games adjustments. | Location is in General Settings>Operator>System Tests>Video Screen Settings>Screen Size Adjust |

HDTV Audio Problems

| | | |
|-----------------------------|--|--|
| No Audio | RCA audio cable is not connected to the system box or HDTV | Connect the RCA audio cable to the system box and then to the proper input on the HDTV. |
| | RCA audio cable is connected to the wrong audio input of the HDTV | You must connect the audio cable to the matching video input selected. For example: If you are using Component 1 the audio must go to Component 1. |
| | HDTV audio is muted | Turn the mute off in the HDTV menu. |
| | Volume is turned down on the monitor or game sounds are set too low. | Adjust the volume on the game to 75% and then adjust the game volume to your desired level. |
| Low volume | Volume is turned down on the monitor or game sounds are set too low. | Adjust the volume on the game to 75% and then adjust the game volume to your desired level. |
| Scratchy or distorted audio | Poor cable connection RCA cable | Be sure the RCA audio cable is securely and entirely connected the mating connectors. |
| No audio | DIP switch settings are incorrect for your application | Refer to Monitor Applications at the back of this manual for proper setup. |

| Flash Code Messages | | |
|------------------------------------|---|---|
| Flash Code (I/O Diode D102) | Code Description | Solution |
| Flash Code 2 | Possible IO board failure | First Check Connections. Turn off game, wait 10 seconds, turn game on. If Problem persists call IT tech support. |
| Flash Code 3 | Info: Last reboot due to Watchdog time out. | Turn off game, wait 10 seconds, turn game on. If Problem persists call IT tech support. |
| Flash Code 4 | Error When updating CID to latest Version | Typically CID failure. Turn off game, wait 10 seconds, turn game on. If Problem persists call IT tech support. |
| Flash Code 5 | Updated USB CID was detected. This is not an error but a notification. | Turn off game, wait 10 seconds, turn game on. If Problem persists call IT tech support. |
| Flash Code 6 | Disconnected Cabinet ID Device (CID) was detected. | Check USB connection. Turn off game, wait 10 seconds, turn game on. If Problem persists call IT tech support. |
| Flash Code 7 | CID Malfunction. Typically CID is defective. | Turn off game, wait 10 seconds, turn game on. If Problem persists call IT tech support. |
| Flash Code 10 | Error When updating USB I/O board to latest version. Typically an I/O board failure | Turn off game, wait 10 seconds, turn game on. If Problem persists call IT tech support. |
| Flash Code 11 | Updated USB I/O board to latest version. This is not an error but a notification. | Turn off game, wait 10 seconds, turn game on. If Problem persists call IT tech support. |
| Flash Code 12 | A disconnected IO board was detected. | Turn off game, Check USB and power connections, turn game on. If Problem persists call IT tech support. |
| Flash Code 13 | I/O board malfunction. Typically I/O board has failed. | Turn off game, wait 10 seconds, turn game on. If Problem persists call IT tech support. |
| Flash Code 14 | Game is incompatible with USB I/O board. | This usually means the wrong type of I/O board. It does not match the system box software. Try turning off game, wait 10 seconds, turn game on. If problem persists call IT tech support. |

| Miscellaneous Problems | | |
|--------------------------------|---|--|
| Symptom | Probable Cause | Solution |
| Unable to exit Operator Menus. | DIPswitch SW202 position 4 is in the on position. | Set position 4 of SW202 to off. Press start to exit. |
| | Test switch wired from the I/O Board is closed. | Verify satellite test switch is not closed. |
| No fluorescent light | No 120 volts A.C. power going to the light fixture. | Verify A.C. voltage to the light fixture. |
| | Defective fluorescent light. | Replace fluorescent light. |
| | Defective starter | Replace the starter. |
| | Defective ballast. | Replace the ballast. |

APPENDIX B – SHOWPIECE INPUT/OUTPUT CONNECTIONS (I/O POWER, TRACKBALL, ETC.)

For Standard Online Kit and Deluxe Retrofit Kit

Trackball Harness Connector Pin Outs

| I/O Board Connector | Trackball Connector |
|----------------------|----------------------|
| PIN WIRE #6 – Black | PIN WIRE #1 – Black |
| PIN WIRE #1 – Red | PIN WIRE #2 – Red |
| PIN WIRE #2 – Yellow | PIN WIRE #3 – Yellow |
| PIN WIRE #3 – Green | PIN WIRE #4 – Green |
| PIN WIRE #5 – Blue | PIN WIRE #5 – Blue |
| PIN WIRE #4 – Purple | PIN WIRE #6 – Purple |

I/O Power Cable Pin Outs

| Pin Number | Wire Color | Function |
|------------|------------|---------------|
| 1 | Yellow | + 12 Volts DC |
| 2 | Black | Ground |
| 3 | Red | + 5 Volts DC |
| 4 | Black | Ground |

Control Panel J203 Connector Pin Outs

| Pin | Color | Function |
|-----|--------------|------------|
| 1 | Green-White | Options |
| 2 | Brown-White | Left |
| 3 | | N.C. |
| 4 | Yellow-White | Right |
| 5 | Violet-White | Flyby |
| 6 | Black | Volume GND |
| 7 | Black-White | Spin |
| 8 | Blue-White | Help |
| 9 | Red-White | Start |
| 10 | Black | Ground |

Lamps J202 Connector Pin Outs

| Pin | Color | Function |
|-----|------------|----------------------|
| 1 | Red-Black | Lamp Power – Buttons |
| 5 | Red-Yellow | Help Lamp |
| 6 | Red-Green | Options Lamp |

Speakers J301

| Pin | Color | Function |
|-----|--------------|-----------------|
| 1 | Yellow-Red | Left Speaker + |
| 2 | Yellow-Green | Left Speaker - |
| 3 | White-Red | Right Speaker + |
| 4 | White-Green | Right Speaker - |

Service Panel

| Pin | Color | Function |
|------|---------------|-------------|
| 1 | Red-Black | Meter Power |
| N.C. | Red-Green | Coin Meter |
| 3 | Orange-White | Volume Up |
| 4 | Orange-Yellow | Volume Down |
| 5 | | N.C. |
| 6 | Blue | Test |
| 7 | Black | Test Ground |

Note: N.C. stands for No Connection

APPENDIX C REPLACEMENT PART NUMBERS

Please refer to these IT part numbers when placing orders.

| Part Number | Description |
|-------------|--|
| 925334000P | SHOWPIECE CABINET, US GOLDEN TEE GOLF 2014 ONLINE HOME EDITION |
| 900146007R | CABINET IDENTIFICATION DEVICE, GOLDEN TEE GOLF |
| 915000310R | CABLE ASSY, USB CABLE, 6 FT. |
| 915000173R | CABLE ASSY, TRACKBALL INTERFACE |
| 915015400R | CABLE ASSY, HDMI, 15 FT. |
| 760007104R | CARD READER, MODEL 7104USB |
| 900334000R | I/O BOARD FOR GT GOLF ONLINE HOME EDITION |
| 815000334 | MANUAL, GT GOLF HOME EDITION ONLINE HOME EDITION |
| 820000333R | MARQUEE, GT GOLF 2014 |
| 850000001R | PUSHBUTTON ASSY, RED WITH VERTICAL MOUNTED SWITCH |
| 850000003R | PUSHBUTTON ASSY, WHITE WITH VERTICAL MOUNTED SWITCH |
| 861000022R | PUSHBUTTON ASSY, BLUE ROUND, ILLUMINATED |
| 861000025R | PUSHBUTTON ASSY, YELLOW ROUND, ILLUMINATED |
| 900075332R | SYSTEM BOX, GT 2014 |
| 753304004 | SYSTEM BOX FILTER |
| 752259500R | SYSTEM BOX FILTER BRACKET |
| 880000030R | TRACKBALL ASSY, 3" WHITE |
| 885000030R | TRACKBALL PLATE FOR 3" TRACKBL WITH STANDOFFS |

APPENDIX D NIGHTHAWK COMPONENT DIAGRAMS

Nighthawk System Box Diagram

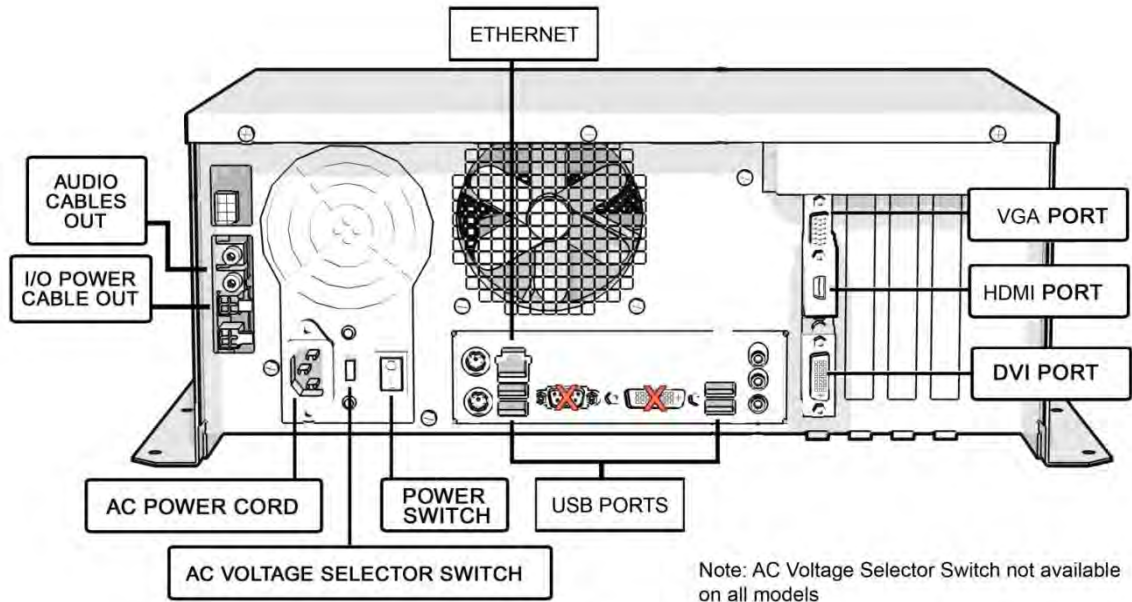

I/O Board Diagram

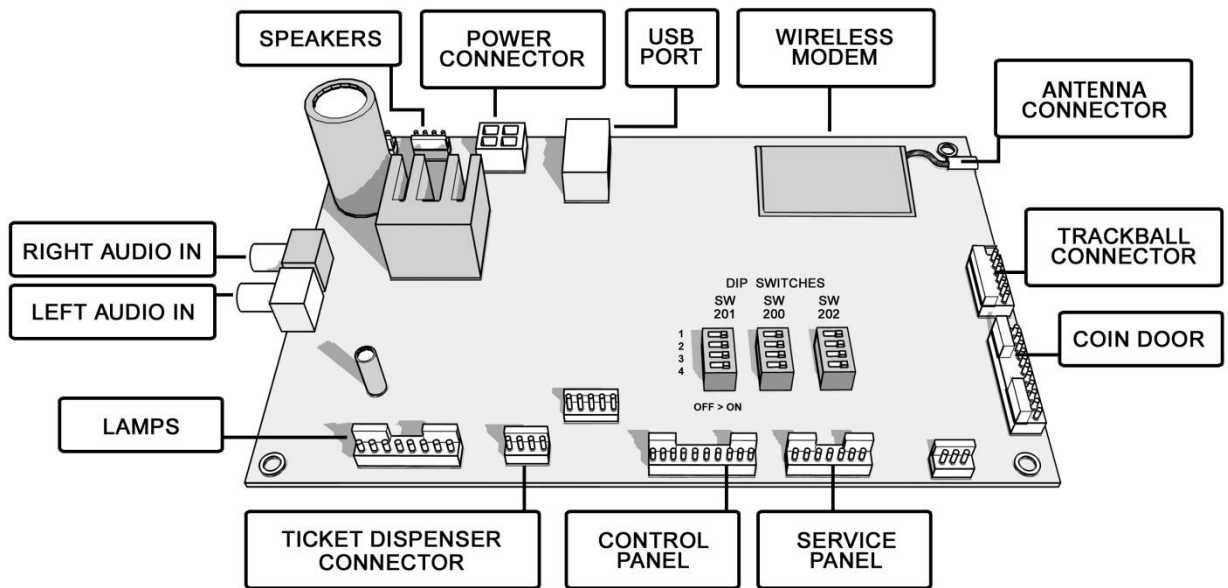

Showpiece Cabinet Connection Diagram

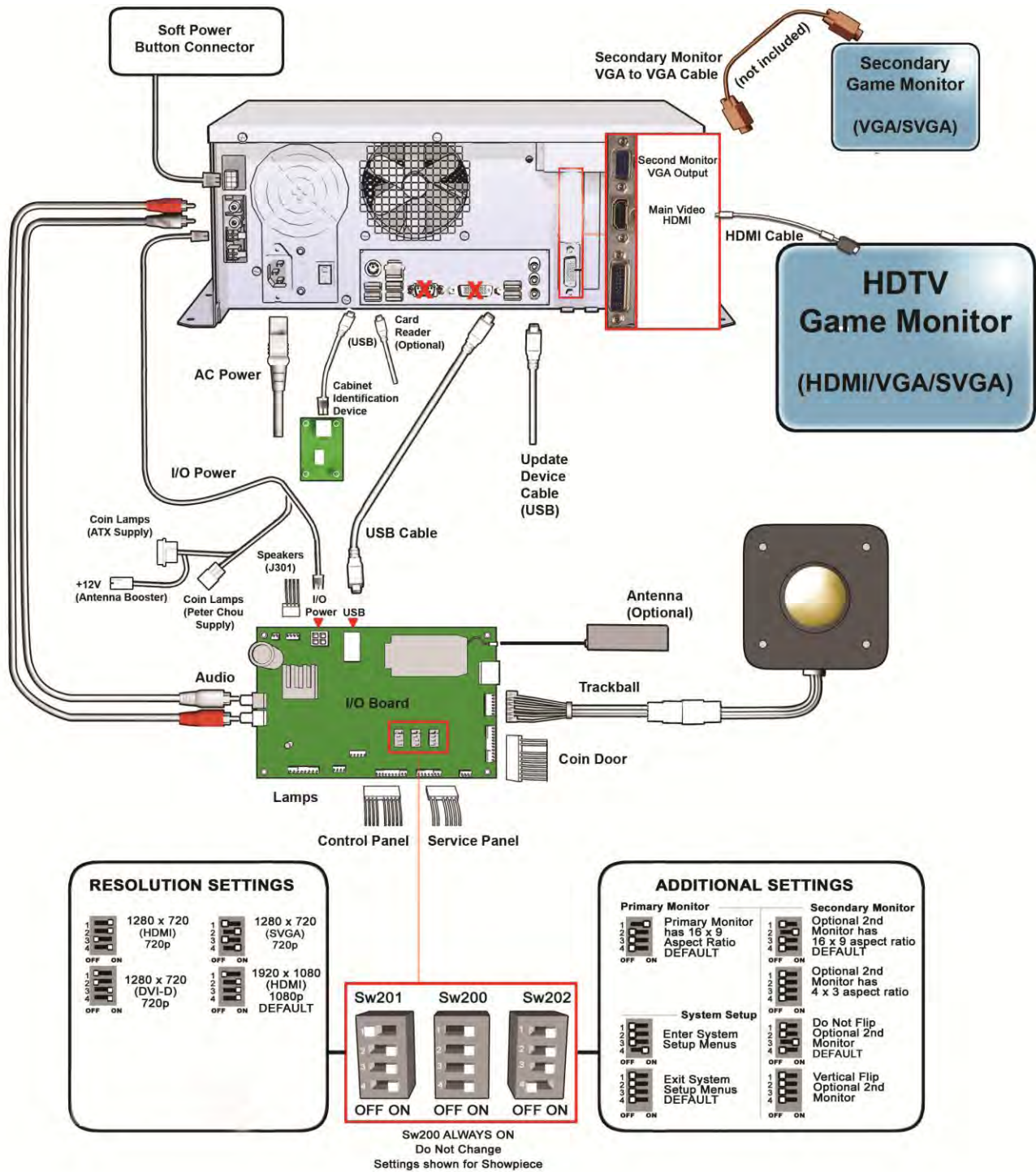

APPENDIX E

GNU General Public License

TERMS AND CONDITIONS FOR COPYING, DISTRIBUTION AND MODIFICATION

0. This License applies to any program or other work which contains a notice placed by the copyright holder saying it may be distributed under the terms of this General Public License. The "Program", below, refers to any such program or work, and a "work based on the Program" means either the Program or any derivative work under copyright law: that is to say, a work containing the Program or a portion of it, either verbatim or with modifications and/or translated into another language. (Hereinafter, translation is included without limitation in the term "modification".) Each licensee is addressed as "you".

Activities other than copying, distribution and modification are not covered by this License; they are outside its scope. The act of running the Program is not restricted, and the output from the Program is covered only if its contents constitute a work based on the Program (independent of having been made by running the Program). Whether that is true depends on what the Program does.

1. You may copy and distribute verbatim copies of the Program's source code as you receive it, in any medium, provided that you conspicuously and appropriately publish on each copy an appropriate copyright notice and disclaimer of warranty; keep intact all the notices that refer to this License and to the absence of any warranty; and give any other recipients of the Program a copy of this License along with the Program.

You may charge a fee for the physical act of transferring a copy, and you may at your option offer warranty protection in exchange for a fee.

2. You may modify your copy or copies of the Program or any portion of it, thus forming a work based on the Program, and copy and distribute such modifications or work under the terms of Section 1 above, provided that you also meet all of these conditions:

a) You must cause the modified files to carry prominent notices stating that you changed the files and the date of any change.

b) You must cause any work that you distribute or publish, that in whole or in part contains or is derived from the Program or any part thereof, to be licensed as a whole at no charge to all third parties under the terms of this License.

c) If the modified program normally reads commands interactively when run, you must cause it, when started running for such interactive use in the most ordinary way, to print or display an announcement including an appropriate copyright notice and a notice that there is no warranty (or else, saying that you provide a warranty) and that users may redistribute the program under these conditions, and telling the user how to view a copy of this License. (Exception: if the Program itself is interactive but does not normally print such an announcement, your work based on the Program is not required to print an announcement.) These requirements apply to the modified work as a whole. If identifiable sections of that work are not derived from the Program, and can be reasonably considered independent and separate works in themselves, then this License, and its terms, do not apply to those sections when you distribute them as separate works. But when you distribute the same sections as part of a whole which is a work based on the Program, the distribution of the whole must be on the terms of this License, whose permissions for other licensees extend to the entire whole, and thus to each and every part regardless of who wrote it.

Thus, it is not the intent of this section to claim rights or contest your rights to work written entirely by you; rather, the intent is to exercise the right to control the distribution of derivative or collective works based on the Program.

In addition, mere aggregation of another work not based on the Program with the Program (or with a work based on the Program) on a volume of a storage or distribution medium does not bring the other work under the scope of this License.

3. You may copy and distribute the Program (or a work based on it, under Section 2) in object code or executable form under the terms of Sections 1 and 2 above provided that you also do one of the following:

a) Accompany it with the complete corresponding machine-readable source code, which must be distributed under the terms of Sections 1 and 2 above on a medium customarily used for software interchange; or,

b) Accompany it with a written offer, valid for at least three years, to give any third party, for a charge no more than your cost of physically performing source distribution, a complete machine-readable copy of the corresponding source code, to be distributed under the terms of Sections 1 and 2 above on a medium customarily used for software interchange; or,

c) Accompany it with the information you received as to the offer to distribute corresponding source code. (This alternative is allowed only for noncommercial distribution and only if you received the program in object code or executable form with such an offer, in accord with Subsection b above.)

The source code for a work means the preferred form of the work for making modifications to it. For an executable work, complete source code means all the source code for all modules it contains, plus any associated interface definition files, plus the scripts used to control compilation and installation of the executable. However, as a special exception, the source code distributed need not include anything that is normally distributed (in either source or binary form) with the major components (compiler, kernel, and so on) of the operating system on which the executable runs, unless that component itself accompanies the executable.

If distribution of executable or object code is made by offering access to copy from a designated place, then offering equivalent access to copy the source code from the same place counts as distribution of the source code, even though third parties are not compelled to copy the source along with the object code.

4. You may not copy, modify, sublicense, or distribute the Program except as expressly provided under this License. Any attempt otherwise to copy, modify, sublicense or distribute the Program is void, and will automatically terminate your rights under this License. However, parties who have received copies, or rights, from you under this License will not have their licenses terminated so long as such parties remain in full compliance.

5. You are not required to accept this License, since you have not signed it. However, nothing else grants you permission to modify or distribute the Program or its derivative works. These actions are prohibited by law if you do not accept this License. Therefore, by modifying or distributing the Program (or any work based on the Program), you indicate your acceptance of this License to do so, and all its terms and conditions for copying, distributing or modifying the Program or works based on it.

6. Each time you redistribute the Program (or any work based on the Program), the recipient automatically receives a license from the original licensor to copy, distribute or modify the Program subject to these terms and conditions. You may not impose any further restrictions on the recipients' exercise of the rights granted herein. You are not responsible for enforcing compliance by third parties to this License.

7. If, as a consequence of a court judgment or allegation of patent infringement or for any other reason (not limited to patent issues), conditions are imposed on you (whether by court order, agreement or otherwise) that contradict the conditions of this License, they do not excuse you from the conditions of this License. If you cannot distribute so as to satisfy simultaneously your obligations under this License and any other pertinent obligations, then as a consequence you may not distribute the Program at all. For example, if a patent license would not

permit royalty-free redistribution of the Program by all those who receive copies directly or indirectly through you, then the only way you could satisfy both it and this License would be to refrain entirely from distribution of the Program.

If any portion of this section is held invalid or unenforceable under any particular circumstance, the balance of the section is intended to apply and the section as a whole is intended to apply in other circumstances.

It is not the purpose of this section to induce you to infringe any patents or other property right claims or to contest validity of any such claims; this section has the sole purpose of protecting the integrity of the free software distribution system, which is implemented by public license practices. Many people have made generous contributions to the wide range of software distributed through that system in reliance on consistent application of that system; it is up to the author/donor to decide if he or she is willing to distribute software through any other system and a licensee cannot impose that choice.

This section is intended to make thoroughly clear what is believed to be a consequence of the rest of this License.

8. If the distribution and/or use of the Program is restricted in certain countries either by patents or by copyrighted interfaces, the original copyright holder who places the Program under this License may add an explicit geographical distribution limitation excluding those countries, so that distribution is permitted only in or among countries not thus excluded.

In such case, this License incorporates the limitation as if written in the body of this License.

9. The Free Software Foundation may publish revised and/or new versions of the General Public License from time to time. Such new versions will be similar in spirit to the present version, but may differ in detail to address new problems or concerns.

Each version is given a distinguishing version number. If the Program specifies a version number of this License which applies to it and "any later version", you have the option of following the terms and conditions either of that version or of any later version published by the Free Software Foundation. If the Program does not specify a version number of this License, you may choose any version ever published by the Free Software Foundation.

10. If you wish to incorporate parts of the Program into other free programs whose distribution conditions are different, write to the author to ask for permission. For software which is copyrighted by the Free Software Foundation, write to the Free Software Foundation; we sometimes make exceptions for this. Our decision will be guided by the two goals of preserving the free status of all derivatives of our free software and of promoting the sharing and reuse of software generally.

NO WARRANTY

11. BECAUSE THE PROGRAM IS LICENSED FREE OF CHARGE; THERE IS NO WARRANTY FOR THE PROGRAM, TO THE EXTENT PERMITTED BY APPLICABLE LAW. EXCEPT WHEN OTHERWISE STATED IN WRITING THE COPYRIGHT HOLDERS AND/OR OTHER PARTIES PROVIDE THE PROGRAM "AS IS" WITHOUT WARRANTY OF ANY KIND, EITHER EXPRESSED OR IMPLIED, INCLUDING, BUT NOT LIMITED TO, THE IMPLIED WARRANTIES OF MERCHANTABILITY AND FITNESS FOR A PARTICULAR PURPOSE. THE ENTIRE RISK AS TO THE QUALITY AND PERFORMANCE OF THE PROGRAM IS WITH YOU. SHOULD THE PROGRAM PROVE DEFECTIVE, YOU ASSUME THE COST OF ALL NECESSARY SERVICING, REPAIR OR CORRECTION.

12. IN NO EVENT UNLESS REQUIRED BY APPLICABLE LAW OR AGREED TO IN WRITING WILL ANY COPYRIGHT HOLDER, OR ANY OTHER PARTY WHO MAY MODIFY AND/OR REDISTRIBUTE THE PROGRAM AS PERMITTED ABOVE, BE LIABLE TO YOU FOR DAMAGES, INCLUDING ANY GENERAL, SPECIAL, INCIDENTAL OR CONSEQUENTIAL DAMAGES ARISING OUT OF THE USE OR INABILITY TO USE THE PROGRAM (INCLUDING BUT NOT LIMITED TO LOSS OF DATA OR DATA BEING RENDERED INACCURATE OR LOSSES SUSTAINED BY YOU OR THIRD PARTIES OR A FAILURE OF THE PROGRAM TO OPERATE WITH ANY OTHER PROGRAMS), EVEN IF SUCH HOLDER OR OTHER PARTY HAS BEEN ADVISED OF THE POSSIBILITY OF SUCH DAMAGES.

How to Apply These Terms to Your New Programs If you develop a new program, and you want it to be of the greatest possible use to the public, the best way to achieve this is to make it free software which everyone can redistribute and change under these terms.

To do so, attach the following notices to the program. It is safest to attach them to the start of each source file to most effectively convey the exclusion of warranty; and each file should have at least the "copyright"

line and a pointer to where the full notice is found.

One line to give the program's name and an idea of what it does.

Copyright (C) yyyy name of author

This program is free software; you can redistribute it and/or modify it under the terms of the GNU General Public License as published by the Free Software Foundation; either version 2 of the License, or (at your option) any later version.

This program is distributed in the hope that it will be useful, but WITHOUT ANY WARRANTY; without even the implied warranty of MERCHANTABILITY or FITNESS FOR A PARTICULAR PURPOSE. See the GNU General Public License for more details.

You should have received a copy of the GNU General Public License along with this program; if not, write to the Free Software Foundation, Inc., 59 Temple Place - Suite 330, Boston, MA 02111-1307, USA.

Copyright 2004 Incredible Technologies, Inc. (IT). Certain programs, identified at IT's Website are free software subject to an associated license.

1. Because certain programs are licensed free of charge, see it's website, there is no warranty for such programs to the extent permitted by applicable law. Except when otherwise stated in writing the copyright holders and/or other parties provide those programs "as is" without warranty of any kind, either expressed or implied, including, but not limited to, the implied warranties of merchantability and fitness for a particular purpose. The entire risk as to the quality and performance of those programs is with you. Should the programs prove defective, you assume the cost of all necessary servicing, repair or correction.

2. In no event unless required by applicable law or agreed to in writing will any copyright holder, or any other party who may modify and/or redistribute those programs be liable to you for damages including any general, special, incidental or consequential damages arising out of the use or inability to use those programs (including but not limited to loss of data or data being rendered inaccurate or losses sustained by you or third parties or a failure of those programs to operate with any other programs), even if such holder or other party has been advised of the possibility of such damages.

A complete machine-readable copy of the source code of those programs and associated license is available to any third party, at the it website.

Contact Information

IT Sales and Service

To purchase additional Golden Tee machines or any of IT's other fine products please visit IT's website at www.itsgames.com and click on **PRODUCTS!**

For the phone numbers below, when prompted "if you know your party's extension you may enter it at any time", enter the three-digit number following the "x".

General Numbers

IT Sales Hotline:

800-262-0323 x383
847-870-7027 x383

Technical Support, Warranty & Repair:

Incredible Technologies, Inc.
800-262-0323 x380 or x381
847-870-7027 x380 or x381
847-454-9008 Fax

Parts and Customer Service:

Incredible Technologies, Inc.
800-262-0323 x386
847-870-7027 x 386
847-454-9156 Fax

Operator Services:

Incredible Technologies, Inc.
800-262-0323 x382
847-870-7027 x382
847-454-9155 Fax

Accounting

Incredible Technologies, Inc.
800-262-0323 x382
847-870-7027 x382
847-454-9007 Fax

IT Mailing Address:

Incredible Technologies, Inc.
200 Corporate Woods Parkway
Vernon Hills, IL 60061

**ITNet Registration Fax Number
847-454-9155**

**Sales Fax Number
847-454-9156**

General Fax Number: 847-870-0120
Tech Services Fax Number: 847-454-9008

IT Vendor Information

Mars Technical Service:

Phone: 800-345-8172

Happ Controls:

Phone: 888-289-4277



Incredible Technologies, Inc.
200 Corporate Woods Parkway
Vernon Hills, IL 60061

Phone (847) 870-7027 (800) 262-0323
www.itsgames.com

APPENDIX F MENU NAVIGATION SHORTCUTS

GAME ICON DESCRIPTIONS

Cooling Icon

The cooling icon (pictured right) will appear in the game's attract mode to warn you that a fan is not operating at minimum recommended standards. If the fans do not operate at suggested levels it may cause your game to overheat and fail.

Call Incredible Technologies Technical Support at 847-870-7027 x381 for assistance.

